

4

3

2

1

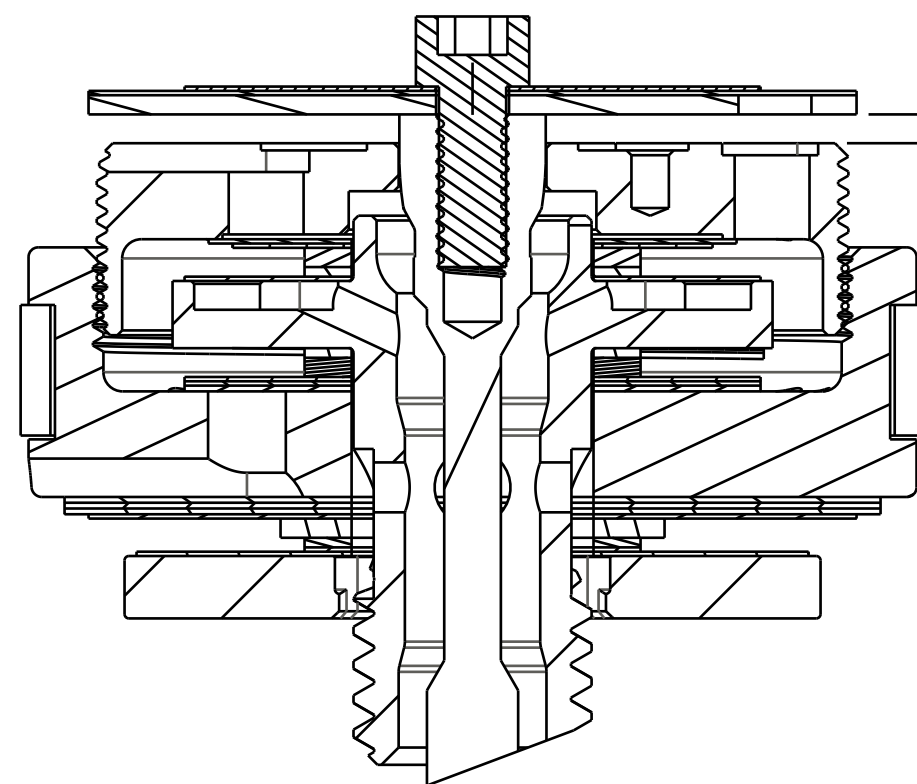

805-02-031-KIT  
Piston Assembly: 2016 Float DPS, [Ø 0.940 Bore] w/ Glyde Ring

TORQUE:  
60+/-5 IN-LB  
CUSTOM SOCKET 398-00-637

210-10-120  
Piston Bolt: Float DPS w/ Check 2mm Cross Holes [1/4-28 X 5/8 Hex]

222-01-316  
Piston: Lockout, Float DPS V3 [.200 TLG, M20 X 0\_.5] 416SS

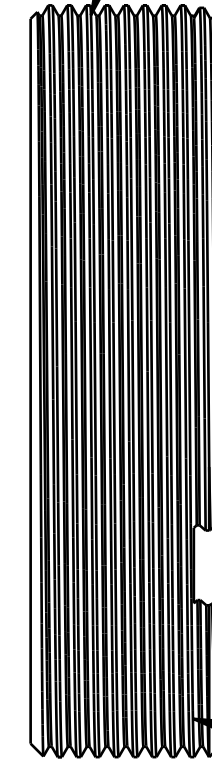
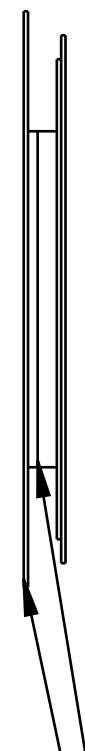
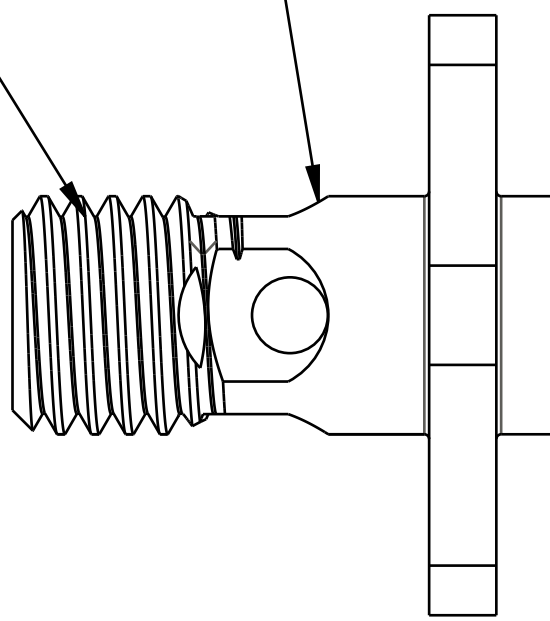
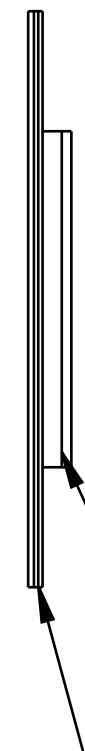
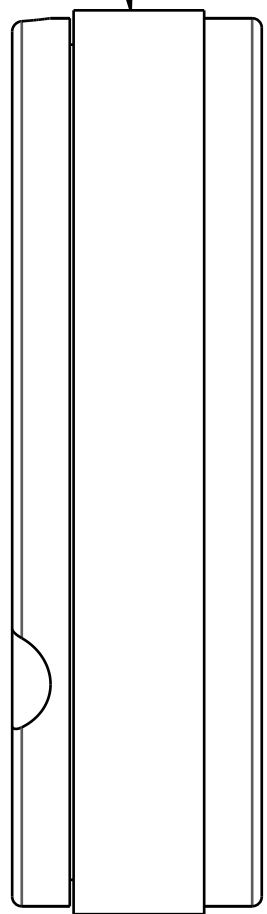
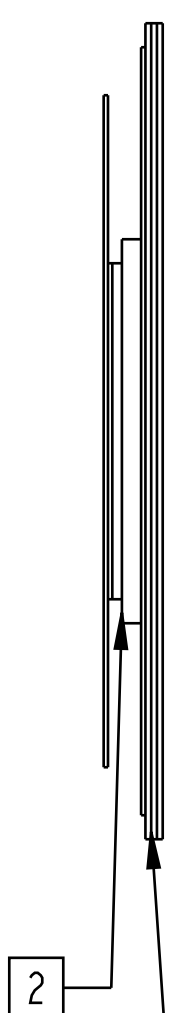
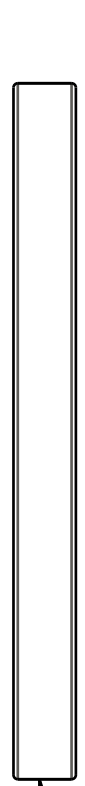

210-10-098  
FLOAT MY2013 Check Piston [.700 OD X .252 ID X .065 TH] Round CNC, SS

805-05-100-KIT  
Valve Stack Assy: 2018 Float DPS, Digressive Compression X-Light, DCXL

805-05-301-KIT  
Valve Stack Assy: 2018 Float DPS, Digressive Rebound Medium, DRM

805-05-201-KIT  
Valve Stack Assy: 2018 Float DPS, Lockout Firm, CMF

TORQUE:  
22+/-2 IN-LB  
CUSTOM SOCKET 398-00-638

- NOTES: (UNLESS OTHERWISE SPECIFIED)
- SHOCK SHOULD HAVE 12-15 REBOUND CLICKS
  - SPACERS MAY BE ADDED OR REMOVED TO ADJUST NUMBER OF REBOUND CLICKS.
  - SPACERS MAY BE ADDED OR REMOVED TO ADJUST NUMBER OF REBOUND CLICKS.
  - SPACERS MAY BE ADDED OR REMOVED TO ADJUST LOCKOUT PLATE LIFT.
  - REFER TO INDIVIDUAL COMPRESSION, REBOUND, OR LOCKOUT VALVE STACK ASSEMBLY DRAWING FOR SPACER DETAILS AND TOTAL STACK HEIGHT MEASUREMENT.
  - USE .030-.047 LIFT SPEC FROM CLOSED TO OPEN FOR REMOTES WITH 210-30-090 OR 210-30-115 CAMS (TREK)

PROPRIETARY -  
THIS DOCUMENT CONTAINS CONFIDENTIAL, PROPRIETARY INFORMATION  
THAT IS FOX PROPERTY. DO NOT DISCLOSE TO OR DUPLICATE  
FOR OTHERS EXCEPT AS AUTHORIZED BY FOX.

**FOX** **FOX Factory, Inc.** Ph 831-768-1100  
130 Hangar Way, Watsonville, CA 95076 USA Fax 831-768-9312

TITLE **Valving Assy: 2018 Float DPS, R/C, DCXL, DRM, CMF [.940 Bore]**

SIZE DWG. NO. **807-06-232-KIT**

PLOT SCALE 2.00:1 SHEET 1 OF 1

4

3

2

ProE ASSEM