

4

3

2

1

D

D

C

C

B

B

A

A

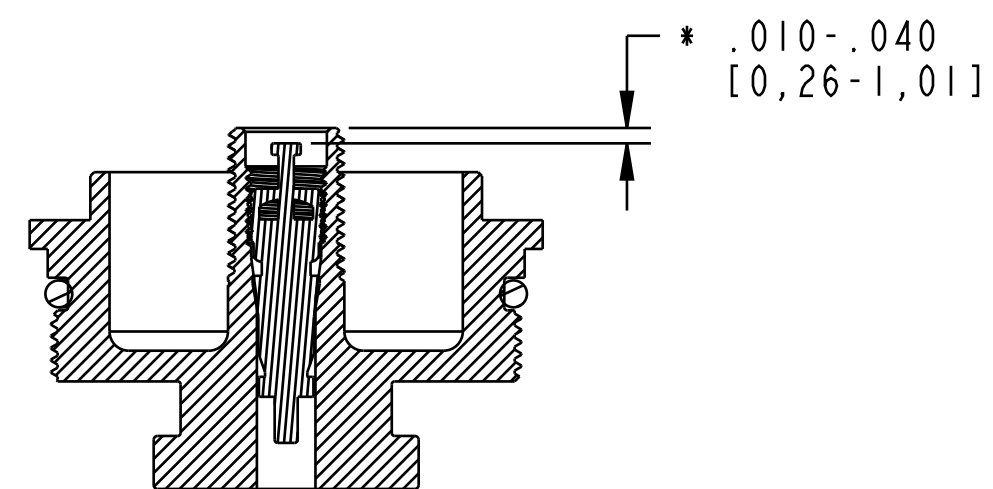
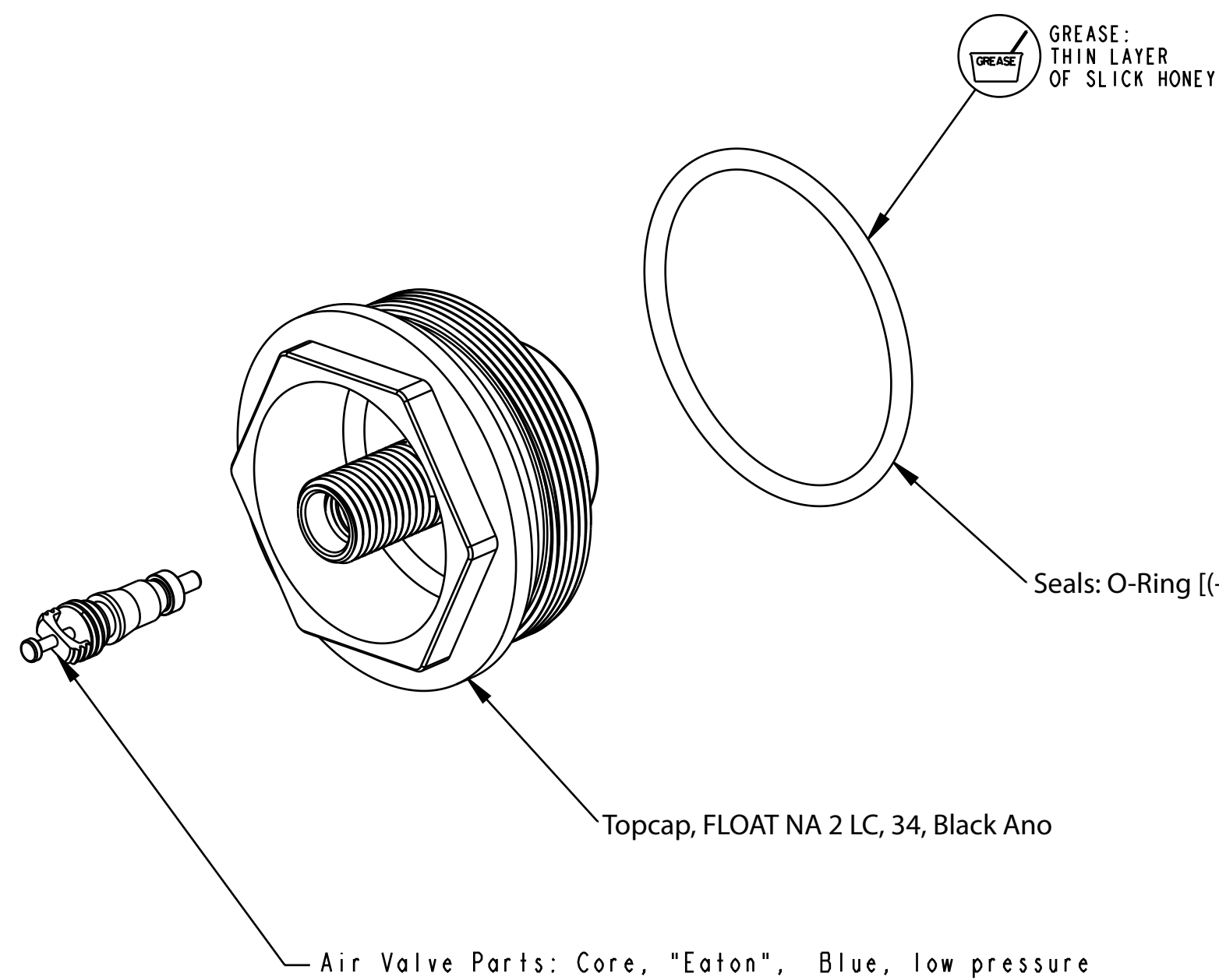

SECTION A-A

- PROPRIETARY -
THIS DOCUMENT CONTAINS CONFIDENTIAL, PROPRIETARY INFORMATION
THAT IS FOX PROPERTY. DO NOT DISCLOSE TO OR DUPLICATE
FOR OTHERS EXCEPT AS AUTHORIZED BY FOX.

FOX		FOX Factory, Inc.	Ph 831-768-1100
		130 Hangar Way, Watsonville, CA 95076 USA	Fax 831-768-9312
TITLE	Topcap Assy, 2018, FLOAT LC NA 2, 34, Black		
SIZE	DWG. NO.	820-05-416-KIT	
C	PLOT SCALE 2.00:1		SHEET 1 OF 1

4

3

2

1